



# PRIODOOR EVX

## Fire protection barrier, Surface-Mounted

Universally usable fire protection barrier with installation frame for easy wall installation. The fire protection barrier is ideally suited for the small-surface to large-scale bulkheading of in-wall and panel distributors in rescue routes. The closure is tightly sealed all around and offers a fire resistance of 30/90 minutes.

### Function

- 30/90 minutes fire resistance, fire retardant/fire resistant
- Smoke protection



■ 2-point locking system



■ Strike plate, top and bottom



■ Turning lever, lockable

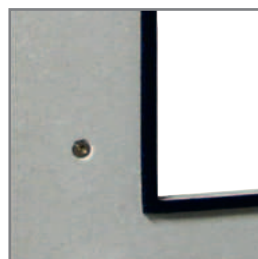

■ Fire and smoke protection seals

## Construction

- Fire-protection barrier for full-surface wall installation
- With circumferential, pre-drilled mounting frame, 22 mm material thickness, 115 mm wide
- Mounting on solid wall
- 2-point door locking device with turning lever and single cylinder, can be integrated into the building locking system
- Single leaf door with stop position DIN right
- Double-leaf design up to H x W 2500 mm x 2300 mm
- Circumferential smoke and fire seals, automatically expand in the event of a fire
- Mounting directly on the wall with pre-drilled holes in mounting frame
- Door leaf easy to hinge and unhinge

## Material characteristic

- Non-combustible board with surface coating, classification A2 – s1, d0
- Standard CPL surface
- Colour light grey, similar to RAL 7035, edges and bevels in different colour

## Scope of delivery

- PRIOD00R EVX with mounting frame
- Mounting hardware for solid wall

PRIOD00R EVX 1-leaf version

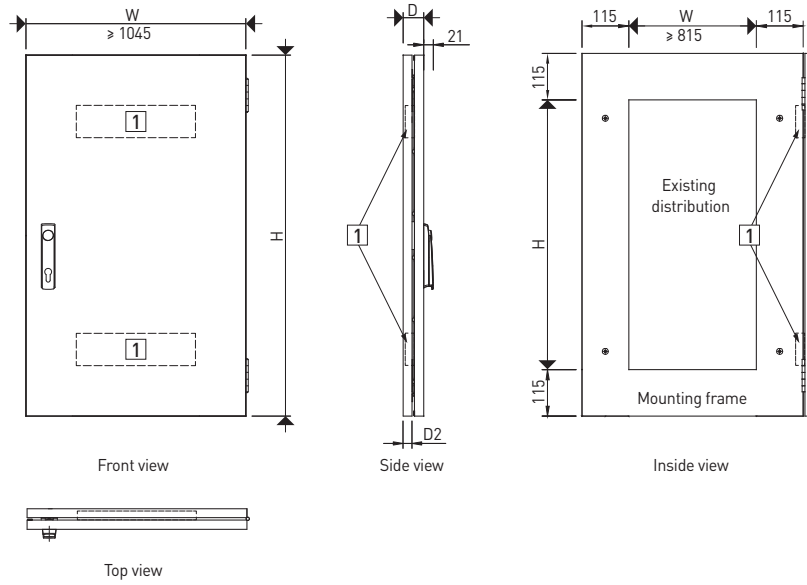



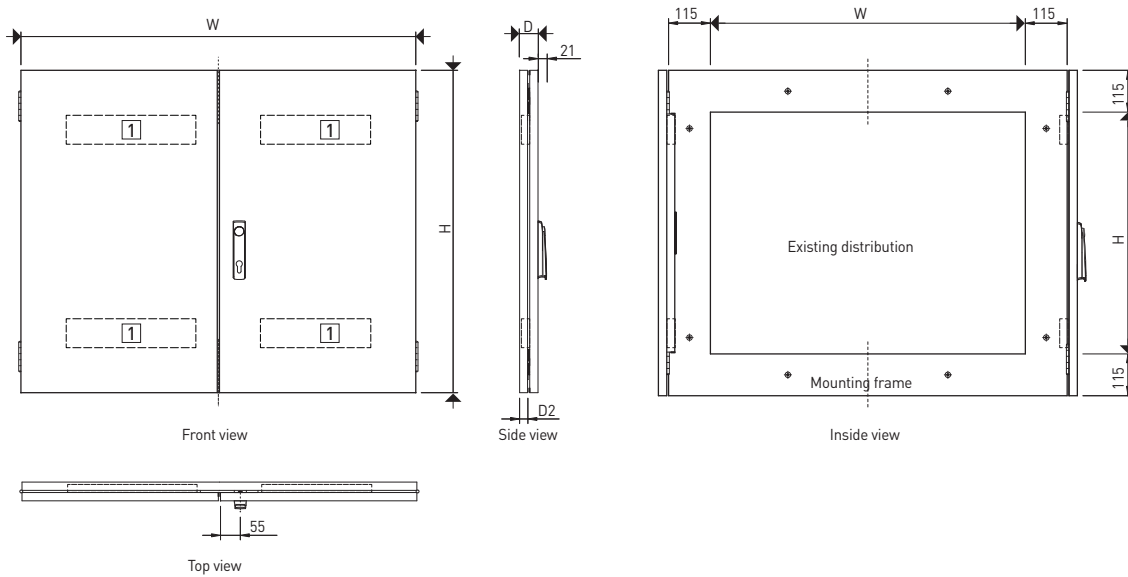

PRIOD00R EVX 2-leaf version

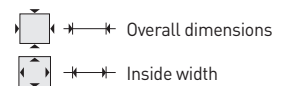

1 PRIODEK H strip on the top and bottom of the door interior, for 30-minute design only (EV3x)

[details in mm]



Art.	 H x W x D mm	 H x W x D mm	 kg	 DIN
<b>EV-SAF</b>	[490 - 2500] x [480 - 2400] x 42	[H-230] x [B-230]		
<b>Fire resistance 30 minutes</b>				
<b>EVX – 1-leaf</b>				
EV31-066-034	895 x 575 x 51	665 x 345 x 0	30	R
EV31-066-056	895 x 795 x 51	665 x 565 x 0	37	R
EV31-081-056	1045 x 795 x 51	815 x 565 x 0	42	R
EV31-081-081	1045 x 1045 x 51	815 x 815 x 0	53	R
EV31-096-034	1195 x 575 x 51	965 x 345 x 0	35	R
EV31-096-056	1195 x 795 x 51	965 x 565 x 0	47	R
EV31-096-081	1195 x 1045 x 51	965 x 815 x 0	60	R
EV31-126-056	1495 x 795 x 51	1265 x 565 x 0	58	R
EV31-126-081	1495 x 1045 x 51	1265 x 815 x 0	73	R
EV31-186-056	2095 x 795 x 51	1865 x 565 x 0	79	R
<b>EVX – 2-leaf</b>				
EV32-096-106	1195 x 1295 x 51	965 x 1065 x 0	72	-
EV32-111-106	1345 x 1295 x 51	1115 x 1065 x 0	80	-
EV32-126-106	1495 x 1295 x 51	1265 x 1065 x 0	88	-
EV32-156-131	1795 x 1545 x 51	1565 x 1315 x 0	125	-
EV32-186-106	2095 x 1295 x 51	1865 x 1065 x 0	119	-
<b>Fire resistance 90 minutes</b>				
<b>EVX – 1-leaf</b>				
EV91-066-034	895 x 575 x 71	665 x 345 x 22	42	R
EV91-066-056	895 x 795 x 71	665 x 565 x 22	58	R
EV91-081-056	1045 x 795 x 71	815 x 565 x 22	67	R
EV91-081-081	1045 x 1045 x 71	815 x 815 x 22	86	R
EV91-096-034	1195 x 575 x 71	965 x 345 x 22	57	R
EV91-096-056	1195 x 795 x 71	965 x 565 x 22	76	R
EV91-096-081	1195 x 1045 x 71	965 x 815 x 22	97	R
EV91-126-056	1495 x 795 x 71	1265 x 565 x 22	94	R
EV91-126-081	1495 x 1045 x 71	1265 x 815 x 22	120	R
EV91-186-056	2095 x 795 x 71	1865 x 565 x 22	129	R
<b>EVX – 2-leaf</b>				
EV92-096-106	1195 x 1295 x 71	965 x 1065 x 0	118	-
EV92-111-106	1345 x 1295 x 71	1115 x 1065 x 0	132	-
EV92-126-106	1495 x 1295 x 71	1265 x 1065 x 0	146	-
EV92-156-131	1795 x 1545 x 71	1565 x 1315 x 0	206	-
EV92-186-106	2095 x 1295 x 71	1865 x 1065 x 0	201	-

You can find the tender text at: [www.priorit.de](http://www.priorit.de)

## Installation

115 mm wide mounting frame has full contact with wall

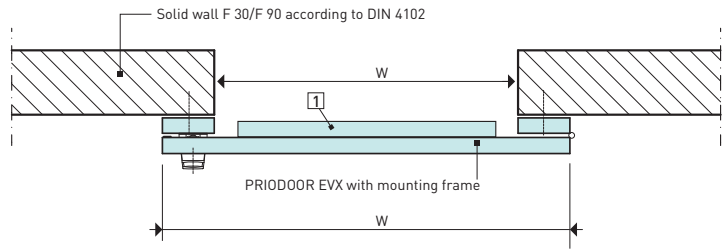

## Mounting frame<sup>1</sup> for additional battens

Use up to three mounting frames<sup>1</sup> to increase the wall distance of the revision cover.

	Distance from wall	1	2	additional frames	max. 3
1-leaf	0 mm	22 mm	44 mm		66 mm
2-leaf					

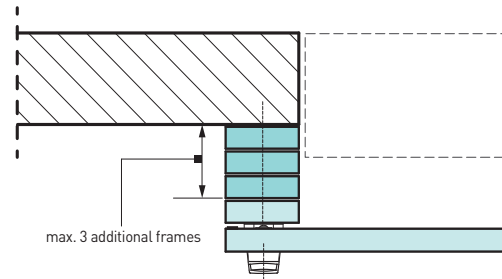

<sup>1</sup> Installation frame only with test report and manufacturer's declaration of conformity

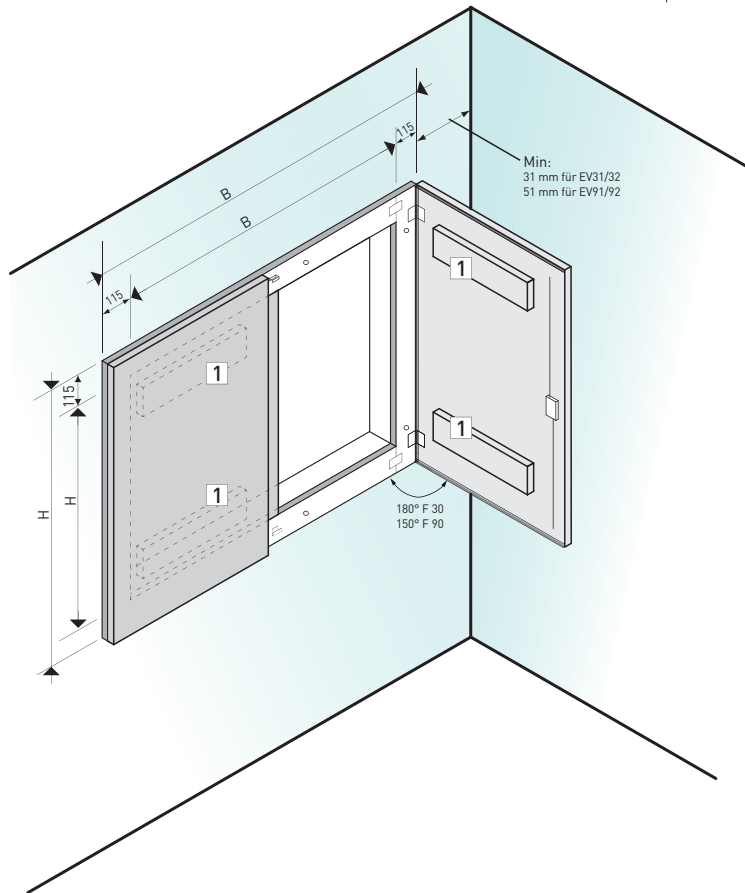

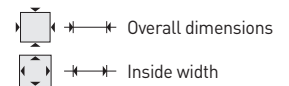

**1** PRIODEK H strip on the top and bottom of the door interior, for 30-minute design only (EV3x)



## Options and accessories

- Various PRIORIT surfaces, see pages 44
- Priming film - can be painted on-site
- Aluminium decor

Art.	 H x W x D mm	 H x W x D mm	 kg
<b>Mounting frame for 1-leaf EVX</b>			
AREV01-066-034	895 x 575 x 22	665 x 345 x 22	11
AREV01-066-056	895 x 795 x 22	665 x 565 x 22	12
AREV01-081-056	1045 x 795 x 22	815 x 565 x 22	13
AREV01-081-081	1045 x 1045 x 22	815 x 815 x 22	15
AREV01-096-034	1195 x 575 x 22	965 x 345 x 22	12
AREV01-096-056	1195 x 795 x 22	965 x 565 x 22	14
AREV01-096-081	1195 x 1045 x 22	965 x 815 x 22	16
AREV01-126-056	1495 x 795 x 22	1265 x 565 x 22	17
AREV01-126-081	1495 x 1045 x 22	1265 x 815 x 22	19
AREV01-186-056	2095 x 795 x 22	1865 x 565 x 22	22
<b>Mounting frame for 2-leaf EVX</b>			
AREV02-096-106	1195 x 1295 x 22	965 x 1065 x 22	18
AREV02-111-106	1345 x 1295 x 22	1115 x 1065 x 22	20
AREV02-126-106	1495 x 1295 x 22	1265 x 1065 x 22	21
AREV02-156-131	1795 x 1545 x 22	1565 x 1315 x 22	26
AREV02-186-106	2095 x 1295 x 22	1865 x 1065 x 22	26